

TYPE TWA300

Dimensions

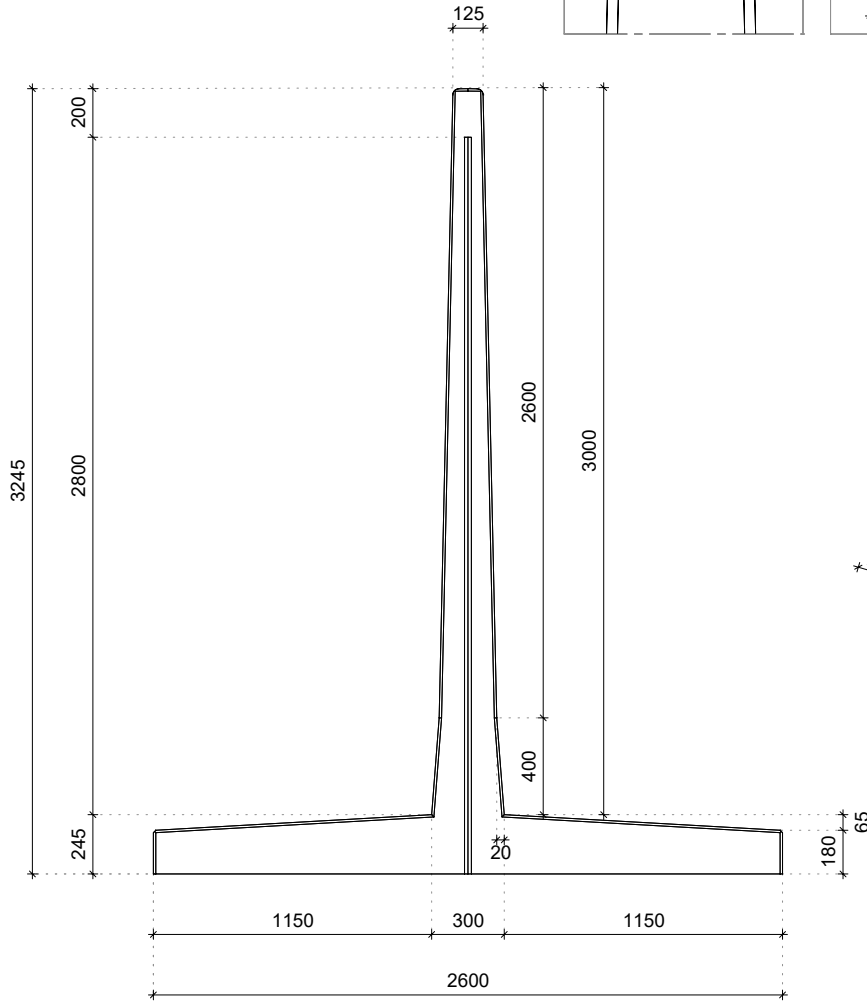

Details

Rounded top edge

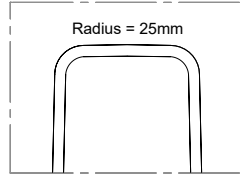

Groove for joining strip

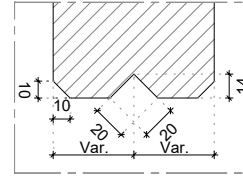

Element connection

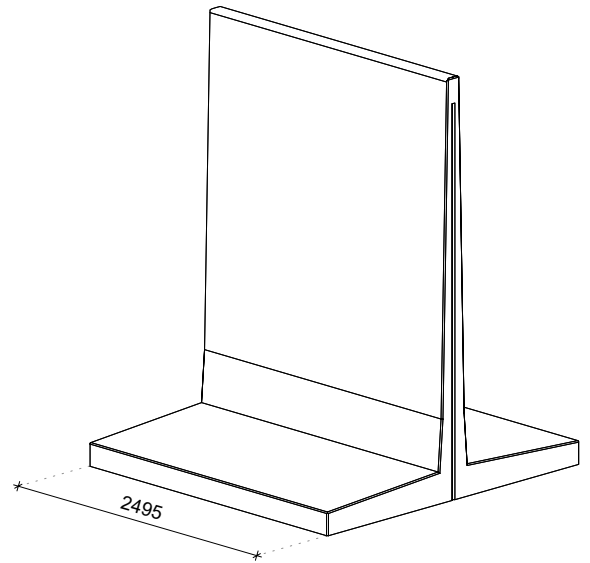
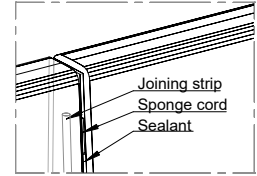

Technical details

Concrete mixture	2nd Generation self-compacting C60/75
Reinforcement steel	B500
Weight	6850kg (L = 2495mm)
Concrete cover	30mm
Dimensional tolerance	+/- 5mm
Concrete surface finish	All visible sides class A (B1 on request)
Design life	50 years
Product warranty	20 years
Environmental class	XA3, XC4, XD3, XS3, XF4
Hoisting device	None, to be placed with clamp

Constructed according to

EN 1990 Eurocode 0	EN 206
EN 1991 Eurocode 1	Incl. national addendums
EN 1992 Eurocode 2	
EN 1997 Eurocode 7	

Produced method



Energy neutral



Filtered rainwater



Sustainable raw materials



Recyclable materials

Certification

